

ProcessDefender™

Motor Load Monitor



Contents

- **Inside the Box** 3
- **Safety** 4
- **Description** 5
- **Getting Started** 7
 - Important Notes 7
 - Installation..... 8
 - Configurator Download and Firmware Updates 8
 - Alarm / Trip Reset 10
- **Programming** 10
 - Home Screen 11
 - Entering and Exiting the Menu 14
 - Menu 1 - AutoSet (1.1.0) 15
 - Menu 2 - General Configuration (2.0.0) 20
 - Menu 3 - Main Alarm Relay (R1); (3.0.0) 34
 - Menu 4 - Pre-Alarm Relay (R2); (4.0.0) 43
 - Menu 5 - General Alarm Relay (R3); (5.0.0) 52
 - Menu 6 - Inputs and Outputs (6.0.0) 56
 - Menu 8 - System Settings (8.0.0) 60
- **Event Log** 63
- **Troubleshooting** 65
- **Parameter List** 66
- **Technical Data** 78
- **Dimensional Details** 80
- **Service Information** 82
- **Customer Notes** 84
- **Warranty** 86

Inside the Box

Please inspect the contents of the box for any shipping damage. Your shipment should contain:



ProcessDefender DIN Rail mountable Sensor



ProcessDefender HMI (LCD Display)



Sensor to HMI cable



Ground wire



USB to Type A cable



Current Transformer - rated to match your Purchase Order (may be shipped separately and comprise either 1 or 3 CTs)



Single-sheet Installation Manual



This User Instruction Manual

Check carefully to ensure that the Current Transducer matches the Motor Full Load Amps of your application - refer to the table on page 7 of this manual. If any items are missing or damaged, please contact your supplier within 24 hours of receipt.

Important Note: *If you have any doubt regarding the contents that you have received, please contact your supplier before proceeding with the installation!*

WARNING

- Please study this manual carefully before installation and programming.
- Installation should only be undertaken by qualified personnel.
- Disconnect power supply circuits before installation.
- Installation must comply with local electrical codes and standards.
- Check installation connections before re-applying power.
- Contact your supplier if you have any questions regarding installation or programming.
- Product failure or damage to external equipment caused by installation errors are not covered by the warranty.

ProcessDefender is an accurate and reliable Motor Load (Power) Monitor, designed to protect rotating equipment from expensive damage and downtime caused by abnormal process overload and underload conditions.

ProcessDefender uses the motor as its own sensor, thereby eliminating the need for external sensors such as temperature probes, pressure sensors, flow monitors or vibration transducers, etc.

ProcessDefender 'learns' the normal process load and then, when instructed to do so, automatically sets itself to protect against abnormal overload and/or underload conditions.

A key feature of ProcessDefender is its ability to protect the Engineer and Operator from Arc Flash. Programming and Alarm Reset is via the externally mounted HMI or Modbus interface. Previous Motor Load Monitors have typically been installed inside a motor control panel and where the user can be exposed to dangerous Arc Flash conditions - a situation where a violent flashover of electrical current can occur and where the user can experience serious injury or even death. ProcessDefender eliminates these concerns.

ProcessDefender includes 3 fully programmable relays. The relays are designated as follows:

- Relay 1: Main Alarm - typically used to shut down the motor in the event of an abnormal process load condition.
- Relay 2: Pre-Alarm - an early warning of an impending main alarm.
- Relay 3: General Alarm - used to signal an array of other monitored parameters such as over / under voltage, phase symmetry (imbalance), locked rotor, exceeded starts per hour limit.

The HMI can display % motor load, HP, kW, Line Voltage, measured Amps.

The ProcessDefender's installation simply requires the Power Transducer to be mounted on a 35mm DIN rail, close to the motor starter. The clamp-on CT is to be installed onto the L1 phase going to the motor, and the HMI is to be mounted in the door of the motor control panel. Interconnecting wiring is clearly shown within this installation Instruction Sheet.

Common applications for the ProcessDefender include:

- Mag Drive Pumps
- Screw (positive displacement) Pumps
- Progressive Cavity Pumps
- Conveyors
- Mixers
- Scrapers
- Crushers
- Circular and Linear Clarifiers
- Belt-driven Fans

For further information, please visit www.h2flow.net

Getting Started

► Important Notes

- a. ProcessDefender, PD100 has one model that is suitable for all motor supply voltages, ranging from single-phase 100-240 VAC to three-phase 200-480 VAC.
- b. It is essential that the Current Transducer complies with the table below:

Motor Full Load Amps / Rated Motor Current	Current Transducer (CT) Size and Number of Passes (See Notes Below)					
	10A	20A	50A	100A	150A	200A
0.83 - 1.0	10					
1.1 - 1.4	7					
1.5 - 2.0	5					
2.1 - 2.5	4					
2.6 - 3.3	3					
3.4 - 5.0	2					
5.1 - 10.0	1					
10.1 - 20.0	1					
20.1 - 50.0	1					
50.1 - 100	1					
101 - 150	1					
151 - 200	1					

Please contact H2flow Controls directly for assistance with motors larger than 200A.

Notes:

1. Please note that the max cable length (84 inches/2.13m) of the ProcessDefender CT cannot be extended.
2. A 'pass' through the Current Transformer equates to the number of times that the L1 wire passes through the Core of the CT.
3. The CT should only measure current going to the motor, i.e., care should be taken to ensure that no other device is taking power from the wire going through the CT.
4. Several advanced features of the PD100 can only be accessed by installing a CT in each phase.

► Installation

Refer to the separate and convenient fold-out sheet for instructions on the installation of the ProcessDefender.

► Configurator Download and Firmware Updates

Downloading the ProcessDefender configurator program and running the setup wizard is necessary for proper programming of the unit. Please scan the QR Code to the right or visit: h2flow.net/processdefender-load-monitor and navigate to the 'Configurator Download' button to download the PD Configurator Firmware.

H2flow Controls may periodically release firmware updates for the ProcessDefender. Applying these updates is essential in order to ensure the product continues to operate as intended. In order to be notified of any new updates, please scan the QR Code to the right and send the auto-generated email it creates, or alternatively, email us at: sales@h2flow.net and request that your name and email address be added to our notification list.

Step-by-step instructions on how to download and install the ProcessDefender configurator and how to properly implement firmware updates can be found in this section. Alternatively, you may choose to scan the QR code to the right for video instructions on how to complete this process or visit h2flow.net/pd100-tutorials



Scan the above QR Code to locate the configurator firmware on H2flow's website.



Scan the above QR Code to receive notifications about firmware updates.



Scan the above QR Code to access video instructions on downloading the configurator and firmware updates.



① Visit www.h2flow.net and on the ProcessDefender product page, locate the Configurator Download button and download the software.



② Locate the Configurator download and run the Configurator Setup Wizard to complete the installation.

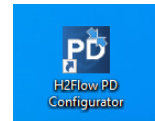

③ Once installation is complete, launch the 'H2flow PD Configurator' software. An shortcut icon should appear on your desktop, for easy access.

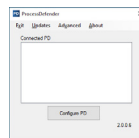

④ Once the PD Configurator has been launched, the above dialog box should appear.

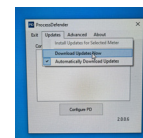

⑤ From the 'Updates' drop down menu, select 'Download Updates Now'.



⑥ Using the Type A to B cable provided with your ProcessDefender, connect your PC to the back of the ProcessDefender HMI.

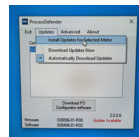

⑦ From the 'Updates' drop down menu, select 'Install Updates for Selected Meter'.

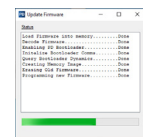

⑧ The above dialog box will appear as available updates are being installed to your ProcessDefender.



⑨ Disconnect the Type A to B cable from the back of the HMI and connect to the PD Sensor and repeat step 7.

▶ Alarm / Trip Reset

Alarms that have been programmed to have their associated relays latched, i.e., remain tripped even after the alarm condition has reverted to its normal state, will need to be manually reset. The reset can be performed by pressing the display's  button for 3 seconds. Alternatively, an Alarm Reset can be achieved by means of the digital input discussed in Menu 6.1.1 of this manual.

Programming

Once installed and powered up, the next step will be to program the ProcessDefender.

The programming structure is arranged with a main menu number and its associated 1 or 2-level sub menus. The overall main menu and first sub menu structure is as follows:

Menu Number	Function	PD100 Parent Menu	PD100 Sub-Menus
N/A	Home Screen	N/A	N/A
Menu 1	AutoSet	1.00	1.1.1 - 1.1.6
Menu 2	General Configuration	2.00	2.1.1 - 2.8.1
Menu 3	Main Alarm Relay (R1)	3.00	3.1.1 - 3.3.3
Menu 4	Pre-Alarm Relay (R2)	4.00	4.1.1 - 4.3.3
Menu 5	General Alarm Relay (R3)	5.00	5.1.1 - 5.3.3
Menu 6	Inputs and Outputs	6.00	6.1.1 - 6.3.3
Menu 8	System Settings	8.00	8.1.1 - 8.3.1

▶ Home Screen

This is the screen that will appear when not in the programming mode and whenever the PD100 is not in an alarm condition.

The Home screen comprises the very valuable data that can be viewed by simply pressing the  or  buttons:

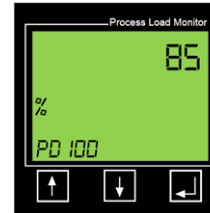

Fig.1.1

Motor Load %

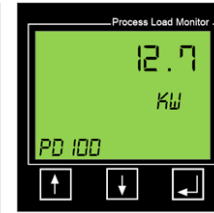

Fig.1.2

Motor Load kW

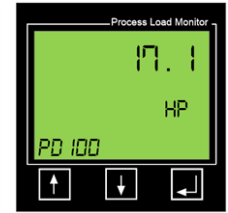

Fig.1.3

Motor Load HP

Note: The default screen is set in Menu 2.7.1 and will be one of the above three screens.



Fig.1.4

Measured Supply
Voltage

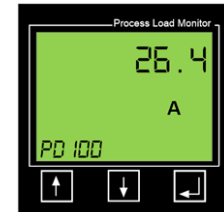

Fig.1.5

Measured Average
Load Amps



Fig.1.6



Fig.1.7



Fig.1.8

Measured Amps in each phase

Note: This requires the installation of a CT in each phase and Menu 2.5.2 set to 3.

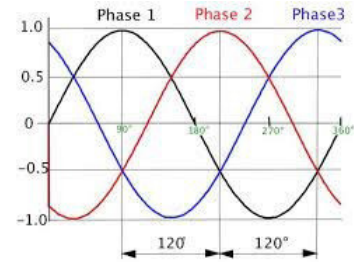

Fig.2.4



Fig.1.9



Fig.2.0



Fig.2.1

Phase-to-Phase Voltage

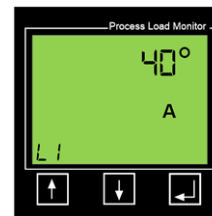

Fig.2.5

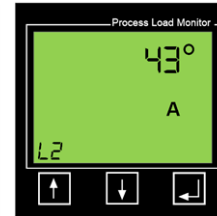

Fig.2.6

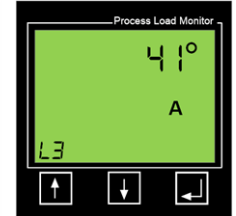

Fig.2.7

The phase angle current is the angle that Current 'lags' the Voltage by.



Fig.2.2

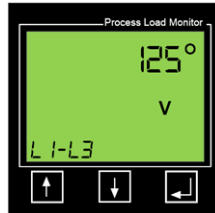

Fig.2.3

The phase angle voltage is the angle between phase L1 voltage and phase L2 voltage (normally about 120 degrees), and between phase L1 voltage and phase L3 voltage (normally about -120 degrees).

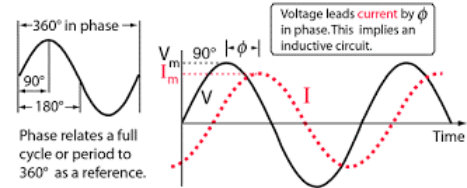

Fig.2.8



Fig.2.9

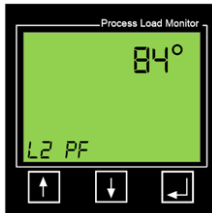

Fig.3.0

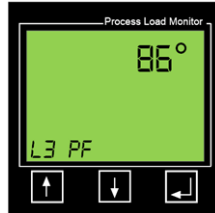

Fig.3.1

Power Factor in each Phase

▶ Entering and Exiting the Menu

To enter or exit the programming menu, press and hold the **Enter** button  for 3 seconds.



Fig.3.2



Fig.3.3

▶ Menu 1 - AutoSet (1.1.0)



Scan the QR Code above or visit:
h2flow.net/pd100-tutorials
to watch an instructional video about Menu 1.

This menu is used to initiate an AutoSet procedure, whereby the PD100 will learn the normal motor load and automatically set overload protection, underload protection, or both over and underload protection.

Important Note: This procedure should not be performed until all other programming of the PD100 is complete. If you are setting up the PD100, you should jump ahead to the **General Configuration** section.

Menu	Description of Value to be Entered
1.1.1	Select whether you want the PD100 to protect against abnormal overload, underload, or both overload & underload
1.1.2	Set Margin % of overload Main Alarm protection, i.e., 20% above 'normal' load
1.1.3	Set Margin % of overload Pre-Alarm protection, i.e., 10% above 'normal' load
1.1.4	Set Margin % of underload Pre-Alarm protection, i.e., 10% below 'normal' load
1.1.5	Set Margin % of underload Main Alarm protection, i.e., 20% below 'normal' load
1.1.6	Apply AutoSet margins

From screen 1.0.0 press the  button to enter screen 1.1.0



When in screen 1.1.0 (Fig.3.4) press the  button to enter 1.1.1 (Fig.3.5)



Fig.3.4



Fig.3.5

Screen 1.1.1 is where you will determine if the PD100 will protect against abnormal Overload only, Underload only, or both Overload and Underload. The default is Both. If this is what you require, simply press the  button to accept and move onto screen 1.1.2.

If you wish to select either Underload protection only or Overload protection only, press either the  or  buttons to display the corresponding screen and then press the  button to accept.

We will now enter the AutoSet margins. The margin is the % difference between the 'normal' motor load and where the trip point will be set. For example, if when the AutoSet procedure is initiated, the normal operating load measured by the PD100 is 60%, and we have a Main Alarm Overload alarm margin of 20%, the trip point will be set at 80% (60 + 20).

Note: Depending on your setting for 1.1.1 you will see the following screens during the next steps:



Menu Number	1.1.1 = BOTH	1.1.1 = OVER	1.1.1 = UNDER	Menu Function
1.1.2	<input checked="" type="checkbox"/>	<input checked="" type="checkbox"/>		Overload Main Alarm Margin %
1.1.3	<input checked="" type="checkbox"/>	<input checked="" type="checkbox"/>		Overload Pre-Alarm Margin %
1.1.4	<input checked="" type="checkbox"/>		<input checked="" type="checkbox"/>	Underload Pre-Alarm Margin %
1.1.5	<input checked="" type="checkbox"/>		<input checked="" type="checkbox"/>	Underload Main Alarm Margin %

The default %s for the Main Alarm margins (1.1.2 and 1.1.5) are 20%, and for the Pre-Alarm margins (1.1.3 and 1.1.4) are 10%.

To adjust these margins, press either  or  buttons to display (for example):



Fig.3.6

Note that in the example shown in Fig.3.6, the number '2' in the value '20' is underlined. Press either the  or  buttons to display the required number for the first digit and then press the  button to confirm and to move onto the second digit.

Repeat the process and again press the  button to confirm and to move to the next menu screen.





Repeat this for all remaining AutoSet margin screens. When pressing the  button for the final entry, the following screen will appear:



Fig.3.7

If you wish to perform an AutoSet procedure, then it is important that you make sure that the monitored application is operating under normal conditions. Once this is confirmed, press the  button to instruct the PD100 to learn this load and apply the margin %s to it. This procedure can be repeated if it is determined that the load was not in its normal state.

If you do not wish to perform an AutoSet procedure at this point, press the  or  button to display the word 'NO' and then press  to confirm.

► Menu 2 - General Configuration (2.0.0)



Scan the QR Code above or visit:
h2flow.net/pd100-tutorials to watch
 an instructional video about Menu 2.



Fig.3.8

After entering the menu structure, press the **↑** button to proceed to the General Configuration menu (2.0.0). While most applications will not require anywhere near all PD100 parameters to be programmed, the following are required for **all** applications.

Important Note: If you are programming the PD100 for the first time, the transition from one sub menu to another will take place automatically when you accept the value of the current one, i.e., if you are programming 2.3.1 and press enter to accept your change, the PD100 will take you directly to 2.4.1.

Menu Number	Description of Value to be Entered
2.1.1	Parameter Lock / Unlock
2.2.1	Unit of Measurement for displayed motor power - HP or kW
2.2.2	Motor size (HP or kW depending on what was set in 2.2.1)
2.3.1	Motor start delay (the time that it will take for the motor to reach full speed and to pick up the normal process load)
2.4.1	Current Transformer Size (Amps)
2.5.1	Number of passes of wire through the CT
2.6.1	Number of supply phases to motor (1 or 3)
2.6.2	Number of CT's installed (PD100 = 1)
2.7.1	Fixed display of measured motor power
2.7.2	Auto-scrolling of measured values
2.8.1	Motor Supply Voltage

► Menu 2.1.1 - Parameter Lock

This menu is related to a feature of the PD100 that allows the Engineer to 'lock' all adjustable parameters of the PD100 to prevent unauthorized tampering. The default setting for this feature is Unlocked. Setting 2.1.1 is normally only undertaken after all programming has been completed.

If you wish to skip this step until programming has been completed, then press the **↓** button to advance from 2.0.0 to enter 2.1.0 and then the **↑** button to advance to Menu 2.2.0. Now proceed to the section below titled **Menu 2.2.1 - Unit of Measurement**.

If however, you wish to set the Parameter Lock, please follow these instructions.



Fig.3.9

From the screen to the left (Fig.3.9), press **↓** to enter the Parameter Lock (PAR.LOK) screen 2.1.1 (Fig.4.0).





Fig.4.0



Fig.4.1





Fig.4.2

When in screen 2.1.1, press the  button to display the screen in Fig.4.1. The left-hand digit will have a flashing underline. Press the  button repeatedly until the number '3' is shown.

Now press the  button to proceed to the middle digit.

Now press the  button repeatedly until the number '6' is shown.

Now press the  button to proceed to the right-hand digit.

Now press the  button repeatedly until the number '9' is shown and then press the  button to accept and show the screen shown in Fig.4.2.

Note the lock symbol above the PD100 in the bottom-left corner. To remove the Parameter lock, simply go through this same procedure again and the lock symbol will be extinguished. The lock and unlock code is '369'.

► Menu 2.2.1 - Unit of Measurement

Depending on where you are in the world, you may prefer to program the PD100 in HP (horsepower) or kW (Kilowatts). The option chosen will determine the unit of measurement for programming the motor's size and how its load is displayed.

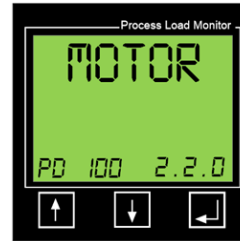

Fig.4.3

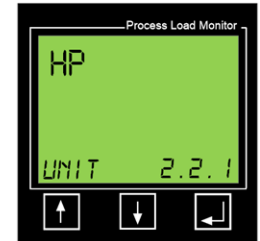





Fig.4.4

To leave menu 2.1.0, press  to enter the Motor Screen (2.2.0) followed by  to enter its sub-menu 2.2.1.

Now press the  or  button to select your preferred unit of measurement for programming the motor details - the options are HP (Horsepower) or kW (Kilowatt). Press  to confirm your selection. The screen will show 'SAVED' for two seconds and then automatically move to menu 2.2.2.

► Menu 2.2.2 - Motor Rated Power (HP or kW determined by 2.2.1)

Here you will program the motor's rated HP or kW (depending on your selection in 2.2.1).

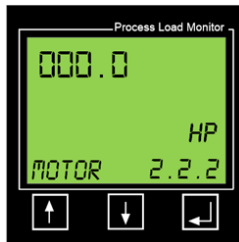







Fig.4.5

If you arrived at menu 2.2.0, press the  button to enter the sub-menu 2.2.1.

In the top-left-side of the display, you will now see four digits which will allow you to enter a motor size up to 999.9 HP (or Kilowatts). Let us assume that your motor size is 15 HP. To enter a value, you will automatically start with the left-hand digit. For this example, we want to:

1. Leave the first digit as '0', so press .
2. You will now program the second digit from the left to '1' by pressing the  button followed by the .
3. You will now program the third digit from the left to a '5' by pressing the  button five times to display the number '5' and then press  to accept.
4. For this example, you should leave the first digit after the decimal point as a '0' and press  to confirm.

The display will show 'SAVED' for 2 seconds and automatically move to menu 2.3.1.

► Menu 2.3.1 - Motor Start Delay

Menu 2.3.1 relates to the Motor Start Delay. The time should be set long enough to allow the motor to reach full speed and for the driven equipment to be under normal load. For example, if the motor is driving a self-priming pump, the time delay should be set long enough for the motor to start and the pump to be primed. However, please note that the PD100 will not enable any of its process protection features until this time period expired.

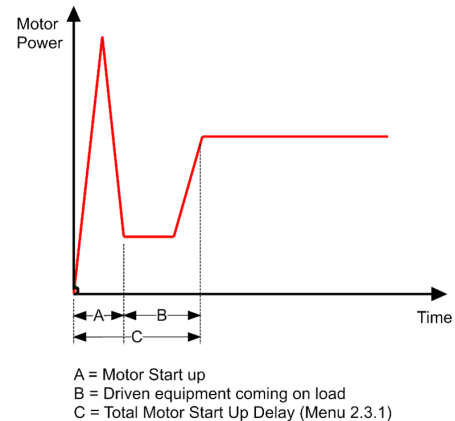

Fig.4.6



Fig.4.7

From menu 2.3.0, press the  button to enter the sub-menu 2.3.1.

In Fig.4.7 (above), the screen shows the factory default Start Delay time of two (2)-seconds.



To adjust this value, press the  or  button. The display will now appear as seen in Fig.4.8 (above). Using the same procedure as described for 2.2.2, adjust the time to that required for the Motor Start Delay. Press the  button to confirm your setting. The display will show 'SAVED' for two-seconds and automatically move to menu 2.4.1.





Fig.4.8

► Menu 2.4.1 - Current Transformer Size (Amps)

The PD100 was purchased with a CT that is related to the Full Load Amps of the motor to which it will be installed. The size of this CT needs to be entered into menu 2.4.1.

If you arrived at menu 2.4.0, press the  button to enter its sub-menu 2.4.1.

Once at menu 2.4.1, you will see a screen that looks like Fig.4.9 (below). The 5A value is the factory default. If your CT is larger, i.e., 20A, 50A, 100A, etc., you will need to enter the correct size shown on the CT.

To adjust this value, press the  or  button. The display will now appear as shown in Fig.5.0 (below). Using the same procedure as described for 2.2.2, adjust the CT size to that required. Press  to confirm your setting. The display will show 'SAVED' for two-seconds and automatically move to menu 2.5.1.

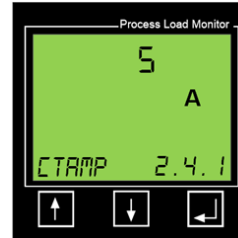

Fig.4.9



Fig.5.0

► Menu 2.5.1 - Number of passes of wire through the CT

Refer to the Table in Section 4.1 of this manual to determine how many passes of wire should have been taken through the center of the CT during its installation. This value will need to be entered into menu 2.5.1.







Fig.5.1







Fig.5.2

If you arrived at menu 2.5.0, press the  button to enter its sub-menu 2.5.1.

The default value for the number of passes is '1'. If this is correct, press  to confirm. To make changes to 2.5.1, press the  or  button. The display will now appear as shown in Fig.5.2 (above). Using the same procedure as described for 2.2.2, adjust the number of passes of wire through the CT. Press  to confirm your setting. The display will show 'SAVED' for two-seconds and automatically move to menu 2.6.1. See the table on page 7 of this manual to determine the number of passes of wire that should have been made through the CT.

► Menu 2.6.1 - Number of Supply Phases

For the PD100 model, the default setting is 3-phase. To accept this value, simply press  to proceed to 2.7.1. To change this to one-phase, press the  or  buttons and press  to accept.

► Menu 2.5.2 - Number of Current Transformers Installed

The default number of CT's installed is 1 (L1 phase). Additional valuable electrical parameters can be displayed in the Home screen, if a CT is installed in all three phases. If two additional CT's have been installed, it will be necessary to set Menu 2.5.2 to a value of '3'.

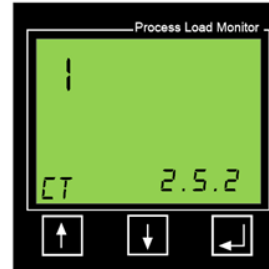

Fig.5.3

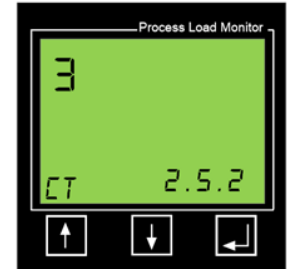







Fig.5.4





To change this value from 1 to 3, simply press the  button followed by the  button.

► Menu 2.6.1 - Number of Supply Phases

For the PD100 model, the default setting is 3-phase. To accept this value, simply press  to proceed to 2.7.1. To change this to one-phase, press the  or  buttons and press  to accept.

► Menu 2.7.1 - Fixed display of measured motor power

Note: If you set 2.7.2 to 'YES' (auto-scrolling), it will override any value set in menu 2.7.1. However, if you set 2.7.2 to 'NO' (the factory default), the PD100 will permanently display the measured motor load format set in 2.7.1 (either HP, kW, or % Load).

To make changes to 2.7.1, press the  or  button. The display will now appear as shown in Fig.5.5 (below). Use the  or  buttons to display the setting that you require (Power HP or Power kW or Power %). Press  to confirm your setting. The display will show 'SAVED' for two-seconds and automatically move to menu 2.7.2 (Main Menu screen).

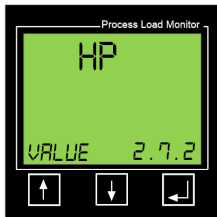

Fig.5.5

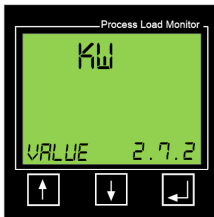

Fig.5.6

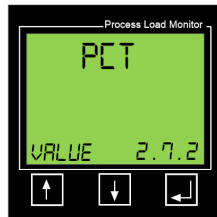



Fig.5.7

► Menu 2.7.2 - Auto-scrolling of measured values of kW, HP, V, A, and %

The factory default value for 2.7.2 is 'NO' (off). If set to 'YES', the PD100 will automatically scroll, every five-seconds, to display its measured readings of kW, HP, Volts, Amps, and Load %.

If you arrived at menu 2.7.0, press the  button to enter its sub-menu 2.7.1 and then press  again to go to menu 2.7.2.

To make changes to 2.7.2, press the  or  button. The display will now appear as shown in Fig.5.9 (below).



Use the  or  buttons to display the setting that you require ('YES' or 'NO'). Press  to confirm your setting. The display will show 'SAVED' for two-seconds and automatically move to menu 2.8.0.



Fig.5.8

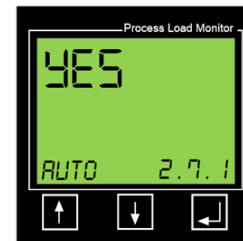







Fig.5.9

► Menu 2.8.1 - Motor Supply Voltage

To enable the PD100 to provide a warning of an abnormal voltage condition, it is necessary for you to program menu 2.8.1 to reflect the motor supply voltage.

If you arrived at Menu 2.8.0, press the  button to display 2.8.1.

In the top-left-side of the display, you will now see three digits which will allow you to enter a motor supply voltage up to 999 Volts. Lets us assume that your motor supply voltage is 480V. To enter a value, you will automatically start with the left-hand digit. For this example, we want to:

1. Leave the first digit as '0', so press the  button.
2. Program the first digit to '4' by pressing the  button four times followed by the  button.
3. Program the second digit to '8' by pressing the  button eight times to display the number '8' followed by the  button to accept.
4. For the third digit, you will press the  button to accept the '0'.

The display will show 'SAVED' for two-seconds and automatically move to the main menu 2.0.0.

► Menus 2.9.1 and 2.9.2 - Time and Date

Section 4.3 of this manual describes how you will check for - and install - any Firmware updates that may have occurred since your unit was manufactured. When undertaking this procedure, the ProcessDefender will automatically update the units current time and date from the PC being used.

Menu 2.9.1 will show the current time and Menu 2.9.2 will show the current date as shown in the following examples:



Fig.6.0

Format: Hour.Min.Sec. (24-hour format, i.e., 10:30PM = 22.30.00)



Fig.6.1

Format: Year.Month.Day

The Time and Date will be used for the ProcessDefender's Event Log feature as discussed in Section 6 of this manual.

► Menu 3 - Main Alarm Relay (R1); (3.0.0)



Scan the QR Code to the left
or visit:
h2flow.net/pd100-tutorials
to watch an instructional video
about Menu 3.

Relay 1 is assigned to protect the monitored equipment from abnormal overload or underload conditions. The relay output is typically used to stop the motor when an abnormal condition is detected. This section will guide you through the steps to set the parameters associated with R1.

Menu Number	Description of Value to be Entered
3.1.1	Configure R1 to protect against abnormal process Overload only, Underload only, or both Over-and Underload
3.1.2	Set Main Alarm Overload trip point in either %, kW, or HP depending on value set in 2.7.1. Menu presence determined by 3.1.1
3.1.3	Set Main Alarm Underload trip point in either %, kW or HP depending on value set in 2.7.1 Menu presence determined by 3.1.1
3.2.1	Set Response Delay for Overload trip. Menu presence determined by 3.1.1
3.2.2	Set Response Delay for Underload trip. Menu presence determined by 3.1.1
3.3.1	Set Relay 1 Latch
3.3.2	Set Relay 1 hysteresis. Menu presence determined by 3.3.1. Only present if Latch set to 'OFF'
3.3.3	Set Relay 1 to Normally Open or Normally Closed (NO or NC)

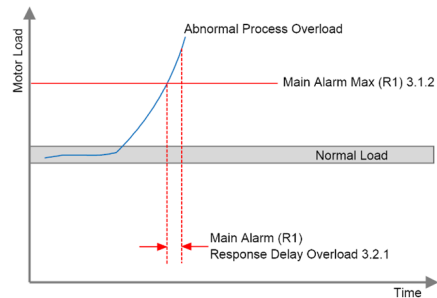

Fig.6.2

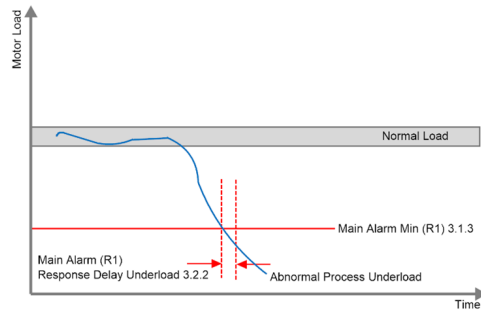

Fig.6.3

From menu 2.0.0, press the  button to proceed to 3.0.0. Press the  button to proceed to 3.1.0.





Fig.6.4



Fig.6.5

► Menu 3.1.1 - Main Alarm Relay (R1) function

In menu 3.1.1 we will configure what we want the Main Alarm Relay, R1 to protect against: either Process Overload, Underload, or both Overload and Underload. To program your required function, press the  button to proceed to menu 3.1.1. The display will now appear as shown in Fig.6.6.

If you require Overload protection, simply press the  button.



If you require the PD100 to protect against Underload or both Overload and Underload, press the  to display the screens shown in Fig.6.7 or Fig.6.8. Finally, press the  button to save your programmed parameter. The word 'SAVED' for two-seconds and the screen will proceed to 3.1.2.



Fig.6.6



Fig.6.7



Fig.6.8

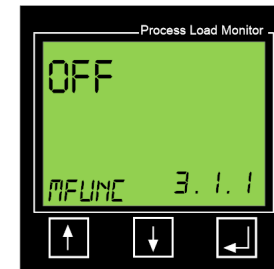

Fig.6.9

► Menus 3.1.2 and 3.3.3 - Main Alarm Relay (R1) Overload and Underload Trip points

Important Notes:

1. Depending on what was set in 2.7.1, one of the screens below (Figs.7.0; 7.1; 7.2) will be seen.
2. Each of the screens assumes that you have set 3.1.1 to Overload protection. If Underload has been selected in 3.1.1 then the menu screen will be 3.1.3. If Overload and Underload has been selected, 3.1.2 will appear and after programming that screen, 3.1.3 will appear.



Fig.7.0



Fig.7.1



Fig.7.2







To make changes to 3.1.2, press the  or  button. The display will now appear as shown in Fig.7.3 (below).



Fig.7.3

Press the  or  buttons to adjust the underlined number and then press the  button to move to the next digit. Next press the  button to accept the complete entry.

Repeat this procedure for 3.1.3. If Underload protection or both Overload and Underload protection was set in 3.1.1.







► Menus 3.2.1 and 3.2.2 - Main Alarm Relay (R1) Overload and Underload Trip response times

The screen will now show either 3.2.1 or 3.2.2 (depending on what was set in 3.1.1).

These menus relate to the **response delays** for either the process overload (3.2.1) or process underload (3.3.2) condition. The response delay is the time-period that the PD100 will take to respond once the load has exceeded the alarm levels that have been set. For an application such as a conveyor, and where a fast response is required to protect against damage caused by a blockage, then the response should be set to a short duration. For a Mag Drive pump, the response delay may be better set to several seconds, in-order-to avoid nuisance alarms caused by short process disruptions as opposed to a run-dry situation.



Fig.7.4

To make changes to 3.2.1 and 3.2.2, press the  or  button. Now press the  or  buttons to adjust the underlined number and then press the  button to move to the next digit and press  again to accept the complete entry.

The screen will now show 3.3.1.

► Menu 3.3.1 - Main Alarm Relay (R1) Latch

This menu relates to the **Main Alarm Relay Latch**. The factory default for the latch is 'ON', which means that an alarm will cause the Main Alarm Relay (R1), to remain in its tripped state until a reset action is performed.





To change the Latch to 'OFF', first press the  or  button. Now press the  or  buttons to change from 'ON' to 'OFF' and press the  button to accept the change.

The screen will now show 3.3.2.

► Menu 3.3.2 - Main Alarm Relay (R1) Hysteresis

This menu relates to the **Relay Hysteresis %** for the main alarm relay and is only applicable if the Relay Latch has been set to 'OFF' in menu 3.3.1.

Applying Hysteresis % to an unlatched relay prevents 'relay chatter / bounce' if the load is close to the alarm level and goes in and out of that level. To reduce unacceptable relay chatter / bounce, increase the Hysteresis %.

To make changes to 3.3.2, press the  button. Using the  and  buttons, adjust the underlined number and then press the  button to accept the required value and move to the next digit. Repeat until all digits are programmed and then press the  button to accept the complete entry.

The screen will now show 3.3.3.

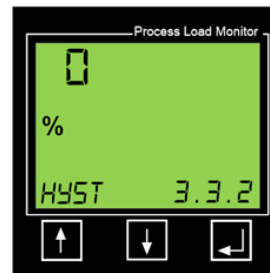







Fig.7.5

► Menu 3.3.3 - Main Alarm Relay (R1) operating status

This menu relates to the Main Alarm Relay Status. The factory default for the status is 'NC' (Normally Closed), which means that the R1 contacts will open when an alarm / trip occurs.



Fig.7.6

To change the status to 'NO' (Normally Open), first press  or  button. Now press the  or  buttons to change from NC to NO and press the  button to accept the change.

The screen will now show 3.0.0.

► Menu 4 - Pre-Alarm Relay (R2); (4.0.0)



Scan the QR Code to the left or visit:
h2flow.net/pd100-tutorials
to watch an instructional video about Menu 4.

Relay 2 is assigned to provide an early warning (Pre-Alarm) of an abnormal overload or underload condition. The relay output is typically used to provide a warning to the equipment operator that something is going wrong. This may be in the form of a light or audible alarm. This section will guide you through the steps to set the parameters associated with R2.

Menu Number	Description of Value to be Entered
4.1.1	Configure R2 to provide a Pre-Alarm warning of an abnormal process Overload only, Underload only or both Over- and Underload
4.1.2	Set Pre-Alarm Overload trip point in either %, kW or HP depending on value set in 2.7.1. Menu presence determined by 4.1.1
4.1.3	Pre-Alarm Underload trip point in either %, kW or HP depending on value set in 2.7.1. Menu presence determined by 4.1.1
4.2.1	Set Response Delay for Pre-Alarm Overload trip. Menu presence determined by 4.1.1
4.2.2	Set Response Delay for Pre-Alarm Underload trip. Menu presence determined by 4.1.1
4.3.1	Set Relay 2 Latch
4.3.2	Set Relay 1 hysteresis. Menu presence determined by 4.3.1. Only present if Latch set to 'OFF'
4.3.3	Set Relay 2 to Normally Open or Normally Closed (NO or NC)

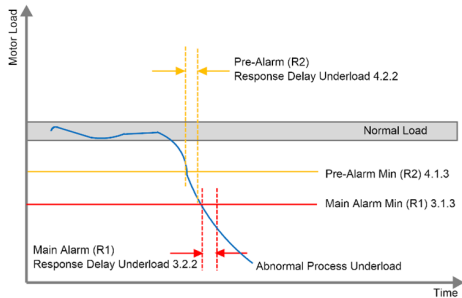

Fig.7.7

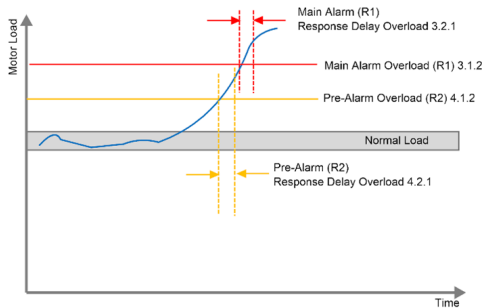

Fig.7.8

Important Note: The parameter that was entered into menu 2.7.1 (% kW or HP), will be used to determine whether 4.1.2 and / or 4.1.3 will be set as a %, kW, or HP.

From Menu 3.0.0, press the button to proceed to 4.0.0. Press the button to proceed to 4.1.0.

► Menu 4.1.1 - Pre-Alarm Relay (R2) function

In Menu 4.1.1 we will configure what we want the Pre-Alarm Relay, R2 to protect against: either Pre-Alarm for Process Overload, Underload, or both Overload and Underload. To program your required function, press the button to proceed to Menu 4.1.1. The display will now appear as seen in Fig.7.9 (below-left).

If you require Pre-Alarm for Overload, simply press the button.

If you require the PD100 to provide a Pre-Alarm for Underload or both Overload and Underload, press the button to display the screen shown in either Fig.8.0 (below-center) or Fig.8.1 (below-right). Now press the button to save your programmed parameter. The word 'SAVED' will appear for two-seconds and the screen will proceed to 4.1.2.



Fig.7.9



Fig.8.0

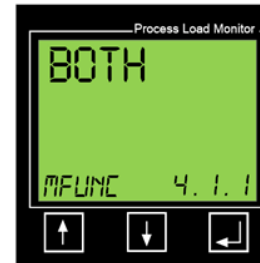

Fig.8.1



Fig.8.2

► Menus 4.1.2 and 4.1.3 - Pre-Alarm Relay (R2) Overload and Underload Trip points

Important Notes:

1. Depending on what was set in 2.7.1, one of the screens below (Figs.8.3; 8.4; 8.5) will be seen:
2. Each of the screens assumes that you have set 4.1.1 to Pre-Alarm for Overload. If Pre-Alarm for Underload has been selected in 4.1.1 then the menu screen will be 4.1.3. If Pre-Alarm for both Overload and Underload has been selected, 4.1.2 will appear and after programming that screen, 4.1.3 will appear.



Fig.8.3



Fig.8.4



Fig.8.5







To make changes to 4.1.2, press the  or  button. The display will now appear as shown in Fig.8.6 (below):



Fig.8.6

Press the  or  buttons to adjust the underlined number and then press the  button to move to the next digit. Next, press the  button to accept the complete entry.

Repeat this procedure for 4.1.3 if Underload protection or both Overload and Underload protection was set in 4.1.1.

The screen will now show either 4.2.1 or 4.2.2 (depending on what was set in 4.1.1).

► Menus 4.2.1 and 4.2.2 - Pre-Alarm Relay (R2) Overload and Underload Trip response times

These menus relate to the response delays for either the process Overload (4.2.1) or process Underload (4.2.2) condition. The response delay is the time-period that the PD100 will take to respond once the load has exceeded the alarm levels that have been set.



Fig.8.7

To make changes to 4.2.1, press the  button. Using the  and  buttons, adjust the underlined number and then press the  button to accept the required value and move to the next digit. Repeat until all digits are programmed and then press the  button to accept the complete entry.

The screen will now show 4.3.1.

► Menu 4.3.1 - Pre-Alarm Relay (R2) Latch

This menu relates to the **Pre-Alarm Relay Latch**. The factory default for the latch is 'OFF', which means that an alarm will cause the Pre-Alarm Relay (R1), to change state while the alarm condition is present, but automatically default back to its normal state when the motor load resumes a normal state. No Reset is required when the Relay Latch is set to 'OFF'.

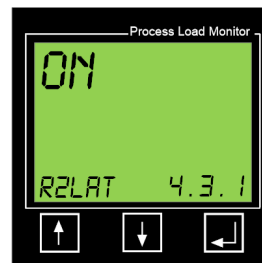







Fig.8.8

To change the Latch to 'ON', first press the  or  button. Now press the  or  buttons to change from 'OFF' to 'ON' and press the  button to accept the change.

The screen will now show 4.3.2.

► Menu 4.3.2 - Pre-Alarm Relay (R2) Hysteresis

This menu relates to the **Relay Hysteresis %** for the pre-alarm relay and is only applicable if the Relay Latch has been set to 'OFF' in Menu 4.3.1.

Applying Hysteresis % to an unlatched relay prevents 'relay chatter' if the load is close to the alarm level and goes in and out of that level. To reduce unacceptable relay chatter / bounce, increase the Hysteresis %.



Fig.8.9

To make changes to 4.3.1, press the **↑** button. Using the **↑** and **↓** buttons, adjust the underlined number and then press the **↵** button to accept the required value and move to the next digit. Repeat until all digits are programmed and then press the **↵** button to accept the complete entry.

The screen will now show 4.3.3.

► Menu 4.3.3 - Pre-Alarm Relay (R2) operating status

This menu relates to the **Pre-Alarm Relay Status**. The factory default for the status is 'NO' (Normally Open), which means that the R2 contacts will close when an alarm / trip occurs.



Fig.9.0

To change the status to 'NC' (Normally Closed), first press the **↑** or **↓** button. Now press the **↑** or **↓** buttons to change from 'NC' to 'NO' and press the **↵** button to accept the change.

The screen will now show 4.0.0. Press the **↑** button to go to 5.0.0 (General Alarm Relay R3).

Summary of Relay 1 and Relay 2 Alarms

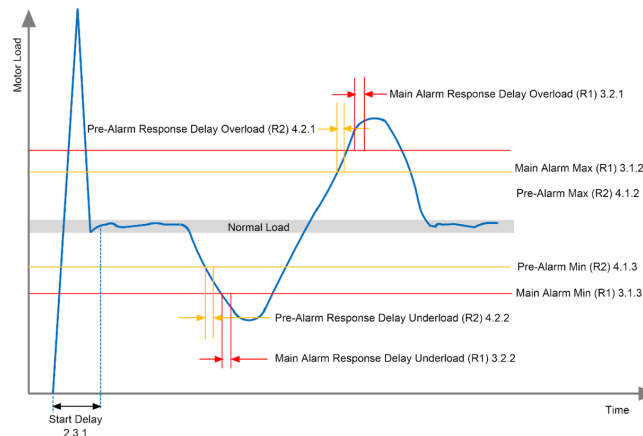

Fig.9.1

► Menu 5 - General Alarm Relay (R3); (5.0.0)



Important Note: Whereas Relays 1 and 2 are related to abnormal 'process' conditions, such as pump run dry and conveyor jams, the General Alarm Relay (R3), is associated with abnormal conditions such as Over Voltage, Under Voltage, phase asymmetry and locked rotor.

Scan the QR Code above or visit:
h2flow.net/pd100-tutorials
to watch an instructional video about Menu 5.

Menu Number	Description of Value to be Entered
5.1.1	Configure R3 to provide an Alarm warning of an abnormal Over Voltage only, Under Voltage only or both Over- and Under Voltage
5.1.2	General Alarm Relay R3 function. Factory configured to display VOLT (cannot be changed)
5.1.3	Configure Over Voltage % trip point
5.1.4	Configure Under Voltage % trip point
5.2.1	Set Response Delay Over Voltage alarm
5.2.2	Set Response Delay Under Voltage alarm
5.3.1	Set Relay 3 Latch
5.3.2	Set Relay 3 Hysteresis. Menu presence determined by 5.3.1. Only present if Latch set to 'OFF'
5.3.3	Set Relay 3 to Normally Open or Normally Closed (NO or NC)

From Menu 4.0.0, press the button to proceed to 5.0.0. Press the button to proceed to 5.1.0.

► Menu 5.1.1 - General Alarm Relay (R3) function

In Menu 5.1.1 we will configure whether we want the General Alarm Relay to activate on Over Voltage, Under Voltage, or both Over- and Under Voltage conditions. The R3 (General Alarm Relay), may also be set to OFF in menu 5.1.1.

Press the or button to display the protection that you require and then press the button to save your programmed parameter. The word 'SAVED' will appear for two-seconds and the screen will proceed to 5.1.2..

For the PD100, Menu 5.1.2 will display 'VOLT' which cannot be changed. Press the button, which will take you to either 5.1.3 if you selected 'OVER' or 'BOTH' in Menu 5.1.1, or to Menu 5.1.4 if you have set Menu 5.1.1 to 'UNDER'.

► Menus 5.1.3 and 5.1.4 - General Alarm Relay (R3) Over Voltage and Under Voltage trip points

In both 5.1.3 and 5.1.4 you will set the % deviation from the normal motor supply that was programmed in Menu 2.8.0. The deviation % can be set at different values for Over Voltage and Under Voltage. For example, you may want to PD100 to provide a General Alarm at 10% Over Voltage and 15% Under Voltage. Remember, these percentages relate to what you programmed in Menu 2.8.0. For example, if 2.8.0 was set to 480V and you set 10% in 5.1.3, then your Over Voltage alarm will activate at $480 + 10\% = 528V$.

To set these values, follow the same procedure that was used when programming 2.8.0.

When complete, press the button to proceed to Menu 5.2.0.



► Menus 5.2.1 and 5.2.2 - General Alarm Relay (R3) Over Volage and Under Voltage response delays

In Menu 5.2.1, we will set the Relay 3 response delay for an Over Voltage alarm and in 5.2.2, we will set the response delay for an Under Voltage alarm. The response delay is the time-period that the PD100 will take to respond once the load has exceeded the alarm levels that have been set.

To set these values, follow the same procedure that was used when programming 3.2.2.

When complete, press the  button to proceed to Menu 5.3.0. Press  again to access Menu 5.3.1.

► Menu 5.3.1 - General Alarm Relay (R3) latch





Here we will reset the Relay 3 latch to be 'ON' or 'OFF' (the default is 'OFF'). Press the  or  buttons to select the value required and then press the  button to accept

The screen will now show 5.3.2.

► Menu 5.3.2 - General Alarm Relay (R3) Hysteresis

This Menu relates to the **Relay Hysteresis %** for the General Alarm relay and is only applicable if the Relay Latch has been set to 'OFF' in Menu 5.3.1.





Applying Hysteresis % to an unlatched relay prevents 'relay chatter' if the measured parameter is close to the alarm level and goes in and out of that level. To reduce unacceptable relay chatter / bounce, increase the Hysteresis %.

To make changes to 5.3.2, press the  button. Using the  and  buttons, adjust the underlined number and then press the  button to accept the required value and move to the next digit. Repeat until all digits are programmed and then press the  button to accept the complete entry.

The screen will now show 5.3.3.

► Menu 5.3.3 - General Alarm Relay (R3) operating status

This Menu relates to the **General Alarm Relay Status**. The factory default for the status is 'NO' (Normally Open), which means that the R3 contacts will close when an alarm / trip occurs.

To change the status to 'NC' (Normally Closed), first press the  or  button. Now press the  or  buttons to change from 'NO' to 'NC' and press the  button to accept the change.

The screen will now show 6.0.0.



Scan the QR Code above or visit:
h2flow.net/pd100-tutorials
 to watch an instructional video about Menu 6.

► Menu 6 - Inputs and Outputs (6.0.0)

Menu 6 will:

- Enable you to assign the Digital input to the ProcessDefender;
- Configure the 4-20mA analog output, and;
- Configure the Modbus communication parameter

Menu Number	Description of Value to be Entered
6.1.1	Configure Digital input to be 'ON' or 'OFF'
6.2.1	Configure the source for the 4-20mA output
6.2.2	Configure the value for the 4mA
6.2.3	Configure the value for the 20mA
6.3.1	Configure the Modbus Baud Rate
6.3.2	Configure Modbus Parity
6.3.3	Configure the Modbus I.D.

From Menu 6.0.0, press the button to enter 6.1.1.

► Menu 6.1.1 - Set Digital Input to ON or OFF

Here we will assign the Digital input to remotely reset any 'latched' alarm relays (using the default setting of 'OFF'), or to also initiate a remote AutoSet of the Load protection parameters if set to 'ON'.

If you do not wish to change the default setting, simply press the button to continue to Menu 6.2.1.

If you wish to assign the Digital input to Remote AutoSet, press the or button to display 'ON' and press the button to accept the change.

The display will now show 6.2.1.



► Menus 6.2.1, 6.2.2 and 6.2.3 - Configure the 4-20mA output

In Menus 6.2.1, 6.2.2 and 6.2.3, we will program the 4-20mA analog output. The first step (6.2.1) is to select the unit of measurement - either % (default), kW, or HP. If % is your preference, simply press to accept and you will be taken to menu 6.2.2. If your preference is either kW or HP, then press the or button to display the required value and press the button to accept the change. The display will now show 6.2.2.

In 6.2.2, we will configure the value that we want the 4mA to represent; the default is '0' and this will be either 0%, 0 kW, or 0 HP depending on what you programmed in Menu 6.2.1. If '0' is your required value, press the button to proceed to 6.2.3.

To make changes to 6.2.2, press the button. Using the or buttons adjust underlined number and then press the button to accept the required value and move to the next digit. Repeat until all digits are programmed and then press the button to accept the complete entry. You will now be taken to 6.2.3.

In 6.2.3 we will configure the value that we want the 20mA to represent; the default is '100' and this will be either 100%, 100 kW, or 100 HP depending on what you programmed in Menu 6.2.1. If '100' is your required value, press the  button to proceed to 6.3.1.

To make changes to 6.2.3, press the  button. Using the  or  buttons adjust underlined number and then press the  button to accept the required value and move to the next digit. Repeat until all digits are programmed and then press the  button to accept the complete entry. You will now be taken to 6.3.1.

► Menu 6.3 - Modbus



The PD100 can be:

- Programmed over Modbus
- Communicate alarm messages over Modbus
- Read parameter settings and values over Modbus

The specific Modbus manual for this can be found by scanning the QR Code to the right or visitng www.h2flow.net/processdefender-load-monitor and locating the Modbus Instruction Manual, located in the Product Literature section.





► Menu 6.3.1 - Configure the Modbus Baud Rate

In 6.3.1 we will program the Modbus Baud Rate. The default is 9600. If changes are required, press either the  or  button to display the required value and press the  button to accept the change. The display will now show 6.3.2.





► Menu 6.3.2 - Configure the Modbus Parity

In 6.3.2 we will program the Modbus Parity with the default being '2 Stop-no parity' (25-NP). If this is your preference, simply press the  button to accept and you will be taken to Menu 6.3.3.

If you wish to change the Modbus Parity to either 15-EP (1 stop-even parity), or 15-OP (one stop-off parity), then press the  or  button to display the required value and press the  button to accept the change. The display will now show 6.3.3.

► Menu 6.3.3 - Configure the Modbus I.D.

In 6.3.3 we will configure the Modbus ID between 0-255. The default value is '10'. If this is your preference, simply press the  button to accept and you will be taken to Menu 8.0.0.

To make changes to 6.3.3, press the  or  buttons to adjust the underlined number and then press the  button to accept the required value and move to the next digit. Repeat until all digits are programmed and then press the  button to accept the complete entry. You will now be taken to screen 8.0.0.



Scan the QR Code above or visit: h2flow.net/pd100-tutorials to watch an instructional video about Menu 8.

► Menu 8 - System Settings (8.0.0)





Menu 8 will:



- a. Enable you to perform a reset of all parameters back to factory defaults (8.1.1 and 8.1.2);
- b. View the Firmware Revision of the Display (8.2.1) and the Display Communication Revision (8.2.2) which will determine the compatibility of the display firmware to the sensor firmware, and;
- c. View and reset Accumulated Motor Run Time.

Menu Number	Description of Value to be Entered
8.1.1	Reset password '369'
8.2.1	Read only value
8.2.2	Read only value
8.3.1	Read only value. Resettable using password '369'

From Menu 8.0.0, press the  button to enter 8.1.1.

► Menu 8.1.1 - Restoring to Factory Defaults

In 8.1.1, we will enter a passcode of '369' to access the reset to factory defaults option. To enter '369', press the  or  buttons to adjust the underlined number and then press the  button to accept the required value and move to the next digit. Repeat with all digits until '369' is displayed and press the  button to accept the complete entry. You will now be taken to 8.1.2.

The default for 8.1.2 is 'NO'. Press the  or  buttons to adjust this to 'YES' and then press the  button to return the PD100 to its factory default settings.

Caution, once entered, this procedure cannot be reversed and it will be necessary to completely reprogram the PD100.

Once initiated, the word 'WAIT' will appear on the display for several seconds before proceeding to Menu 8.2.1. Menus 8.2.1 and 8.2.2 are 'read only' values and may be helpful when troubleshooting with a factory service technician.

► Menu 8.2.1 - Firmware Revision

Menu 8.2.1 is the firmware revision number, i.e., R25.

► Menu 8.2.2 - HMI Communications Revision

May be required for factory troubleshooting

► Menu 8.3.1 - Accumulated Motor Run Time

The PD100 displays the time (in hours), that the motor has run for:



Fig.9.2

The run time can be reset to zero via Menu's 8.3.2 and 8.3.3:

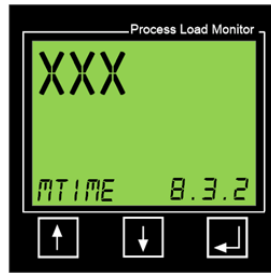









Fig.9.3



Fig.9.4

In Menu 8.3.3, enter the passcode '369' using the  and  buttons to select the required numerical value and press the  button to accept and move to the next digit. After pressing the  button to accept the full passcode of '369', you will see Menu 8.3.3.

Press the  or  button until the word 'YES' is displayed and then press the  button to reset the motor run time back to zero hours.

Event Log

ProcessDefender includes a very valuable Event Log feature that will allow the Engineer to download and study events that will be time and date stamped. This data can be invaluable when trying to determine the cause of events such as an underload trip that consistently occurs at a specific time of day.

To access the event log data, you will need to connect a PC that has the ProcessDefender Configurator program installed. Launch this program and connect the Sensor to the PC using the supplied USB to Type A cable.

The following dialog box (Fig.9.5) will appear on your PC:

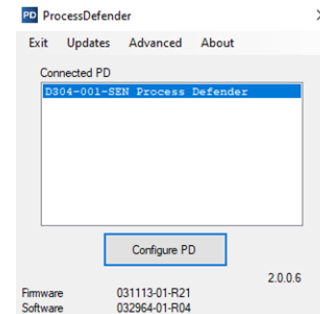

Fig.9.5

Now click on 'Configure PD' to show the following screen:

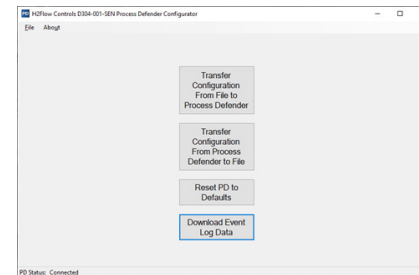

Fig.9.6

Now click on 'Download Event Log Data'. A dialog box will appear that asks you if you want to update the Time in ProcessDefender. Click 'Yes.' A new dialog box will appear that confirms the time has been updated.

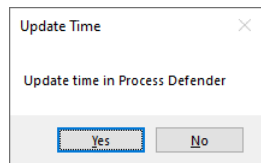

Fig.9.7

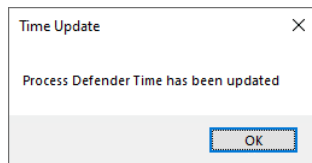

Fig.9.8

Click 'OK' to close the Time update dialog box. The event log data will appear and will look similar to the one below. As can be seen, the data includes the day, month, date, year, time and the type of event.

This data can be exported by clicking on the 'Save to file' tab. The data will be saved as a *.csv format. You will need to enter the file name that you want to use and the location of where you want to save it.

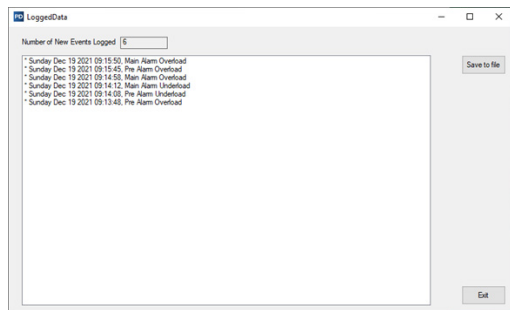

Fig.9.9

Troubleshooting

Problem	Solution
The Display is not activated/illuminated	<ol style="list-style-type: none"> 1. Check that the cable between the Display and Sensor is correctly installed 2. Check to see if the green LED is illuminated in the bottom-right corner of the HMI socket on the Sensor 3. Check to see if the yellow LED is flashing in the bottom-left corner of the HMI socket on the Sensor
Displayed motor load appears to be inaccurate	<ol style="list-style-type: none"> 1. Check that the correct size CT has been installed 2. Check that the correct number of passes of wire have been made through the center of the CT. Refer to the Table in Section 4.1 of this manual 3. Check that the correct motor size has been entered in menu 2.2.2 4. Check that menu 2.4.1 has been set correctly for the installed CT 5. Check that the number of passes through the CT has been entered correctly into menu 2.5.1 6. Check that the number of supply voltage phases (3 or 1) has been entered correctly into menu 2.6.1 7. Check that the supply voltage has been entered correctly into menu 2.8.1
The unit activates a Main or Pre-Alarm alarm during normal process load conditions	The settings for the Main Alarm R1 or Pre-Alarm, may require adjustment in Menus 3 and 4
The unit does not activate a Main or Pre-Alarm alarm during abnormal process load conditions	The settings for the Main Alarm R1 or Pre-Alarm, may require adjustment in Menus 3 and 4
The unit activates a Main or Pre-Alarm too fast or not fast enough	Check and adjust the R1 and / or R2 Response Delays in menu 3.2.1 and 4.2.1

Parameter List

Display I.D.	Function	Display Text	Range	Default	Symbol
	Measured power in % of rated power		0-999		%
	Measured power in kW		0.00-999.0		KW
	Measured power in HP		0.0-999.0		HP
	Measured supply voltage		0-528		V
	Measured current		0.0-999A		A
	L1 Amps				A
	L2 Amps				A
	L3 Amps				A
	L1-L2 Voltage				V
	L2-L3 Voltage				V
	L3-L1 Voltage				V
	L1-L2 Phase Angle 'Voltage'				xxx° and V
	L1-L3 Phase Angle 'Voltage'				xxx° and V
	L1 Phase Angle 'Current'				xx° and A
	L2 Phase Angle 'Current'				xx° and A
	L3 Phase Angle 'Current'				xx° and A
	L1 Power Factor				xx°
	L2 Power Factor				xx°
	L3 Power Factor				xx°
1.00	Autoset	"AUTO"			
1.10	Choose auto setup setting	"A.SET"			
1.1.1	Select Autoset mode	"BOTH", "OVER" or "UNDER"		"BOTH"	
1.1.2	Max main margin (Relay 1) Sensor alarm 1	"MAXM"	0-50	20	%
1.1.3	Max pre margin (Relay 2) Sensor alarm 3	"MAXP"	0-50	10	%
1.1.4	Min pre margin (Relay 2) Sensor alarm 4	"MINP"	0-50	10	%
1.1.5	Min main margin (Relay 1) Sensor alarm 2	"MAXM"	0-50	20	%
1.1.6	Apply Autoset?	"YES" or "NO"		"YES"	

Display I.D.	Function	Display Text	Range	Default	Symbol
2.0.0	Configuration	"CONFIG"			
2.1.0	Parameter lock/unlock	"PAR.LOK"			
2.1.1	Parameter lock/unlock code		000-999	369	Lock symbol
2.2.0	Rated Motor Power	"MOTOR"			
2.2.1	Choose kW or HP	"KW" or "HP"		"KW"	KW/HP
2.2.2	Configure rated motor power kW		0.1-745	2.2	kW/W
2.2.2	Configure rated motor power HP		0-999		HP
2.3.0	Start delay	"ST DEL"			
2.3.1	Configure start delay		0-255	2	S
2.4.0	Primary CT current	"PCT.AMP"			
2.4.1	Configure primary CT current		5-1000	5	A
2.5.0	Number of turns of the primary wire through the CT	"TP CT"			
2.5.1	Turns value		1-10	1	
2.5.2	Number of CT's installed	"CT"	1 or 3	1	
2.6.0	Number of phases	"PHASES"			
2.6.1	Configure number of phases	"1" or "3"	"1" or "3"	3	
2.7.0	Default value	"DEFVAL"			
2.7.1	Default parameter, "main alarm", "pre alarm" and "display measurement"	"PCT", "KW", "HP"		"PCT"	
2.7.2	Auto scroll of values	"YES/NO"		"NO"	
2.8.0	Motor operating voltage	"M VOLT"			
2.8.1	Configure operating voltage		0-600	380	V
2.9.0	Event log time and date	"TIME"			
2.9.1	Event log time. Hour.Minutes.Seconds	"TIME"	0-24 hour, 0-59 minutes, 0-60 seconds		
2.9.2	Event log date. Year.month.day	"DATE"	0-99 years, 0-12 months, 1 - day limit for month		

Display I.D.	Function	Display Text	Range	Default	Symbol
3.0.0	Main alarm, relay 1.	"MAIN.R1"			
3.1.0	Main alarm settings	"M SET"			
3.1.1	Configure R1 protective function		"OVER", "UNDER", "BOTH" or "OFF"		
3.1.2	Configure max trigger point, as percent of motor rated input power. (Only show selected monitor source)	"MAXM"	0-150	125	%
	Configure max trigger point, as measured input power in KW. (Only show selected monitor source)		0.0-745.0	0	kW
	Configure max trigger point, as percent of motor rated input power. (Only show selected monitor source)		0-999	0	HP
3.1.3	Configure min trigger point, as percent of motor rated input power. (Only show selected monitor source)	"MIN M)	0-150	0	%
	Configure min trigger point, as measured input power in KW. (Only show selected monitor source)		0-745	0	kW
	Configure min trigger point, as measured input power HP. (Only show selected monitor source)		0-20	0	HP
3.2.0	Response delay	"RES.DEL"			
3.2.1	Configure response delay overload	"OVER"	0.5-255	0.5	S
3.2.2	Configure response delay underload	"UNDER"	0.5-255	0.5	S
3.3.0	Relay 1 latch	"R1 LAT"			
3.3.1	Configure relay 1 Latch reset	"ON" or "OFF"		"ON"	
3.3.2	Configure relay 1 hysteresis %		0-50	0	%
3.3.3	Configure as normally closed or normally open	"NC" or "NO"		"NC"	
4.0.0	Pre alarm, relay 2	"PRE R2"			
4.1.0	Pre alarm settings	"PRE.SET"			
4.1.1	Configure R2 protective function		"OVER", "UNDER", "BOTH" or "OFF"	"OFF"	
4.1.2	Configure max trigger point, as percent of motor rated input power. (Only show selected monitor source)	"MAX P"	0-150	100	%
	Configure max trigger point, as measured input power in kW. (Only show selected monitor source)		0.0-745.0	0	kW
	Configure max trigger point, as measured input power HP. (Only show selected monitor source)		0-999	0	HP

Display I.D.	Function	Display Text	Range	Default	Symbol
4.1.3	Configure min trigger point, as percent of motor rated input power. (Only show selected monitor source)	"MIN P"	0-150	0	%
	Configure min trigger point, as measured input power in kW. (Only show selected monitor source)		0-745	0	kW
	Configure min trigger point, as measured input power HP. (Only show selected monitor source)		0-20	0	HP
4.2.0	Response delay	"RES/DEL"			
4.2.1	Configure response delay overload		0.5-255	0.5	S
4.2.2	Configure response delay underload		0.5-255	0.5	S
4.3.0	Relay 2 latch	"R2 LAT"			
4.3.1	Configure relay 2 Latch reset	"ON" or "OFF"		"ON"	
4.3.2	Configure relay 2 hysteresis %		0-50	0	%
4.3.3	Configure as normally closed or normally open	"NC" or "NO"		"NO"	
5.0.0	General alarm, relay 3	"GEN R3"			
5.1.0	Monitor function	"GEN SET"			
5.1.1	Configure R3 protective function	"OVER"; "UNDER"; "BOTH" or "OFF"		"OFF"	
5.1.2	Configure source as percent of motor rated input power, measured input power in kW, measured input power HP or voltage	"VOLT"		"VOLT"	
5.1.3	Configure max trigger point, as percent of operating voltage	"MAX G"	0-255	110	%
5.1.4	Configure min trigger point, as percent of operating voltage	"MIN G"	0-255	95	%
5.2.0	Response delay	"RES.DEL"			
5.2.1	Configure response delay overload		0.5-255	0.5	S
5.2.2	Configure response delay underload		0.5-255	0.5	S
5.3.0	Relay 3 latch	"R3 LAT"			
5.3.1	Configure relay 3 Latch reset	"ON" or "OFF"		"OFF"	
5.3.2	Configure relay 3 hysteresis %		0-50	0	%
5.3.3	Configure as normally closed or normally open	"NC" or "NO"		"NO"	

Display I.D.	Function	Display Text	Range	Default	Symbol
6.0.0	Inputs / Outputs	"IN/OUT"			
6.1.0	Digital input	"DIG IN"			
6.1.1	Digital input, autoseg trigger	"ON" or "OFF"		"OFF"	
6.2.0	Analog output	"A OUTS"			
6.2.1	Configure analog output source (measured power in percent of rated power)	"PCT"		"PCT"	
6.2.2	Configure range 4mA		0-999	0	%, KW, HP
6.2.3	Configure range 20mA		0-999	100	%, KW, HP
6.3.0	Modbus	"MODBUS"			
6.3.1	Configure modbus baud rate	"4800", "9600", "14400", "19200", "24000", "28800", "33600", "38400", "43200", "48000", "52800", "57600", "62400", "67200", "72000", "76800", "81600", "86400", "91200", "96000", "100800", "105600", "110400", "115200", "120000", "124800", "129600", "134400", "139200", "144000", "148800", "153600", "158400", "163200", "168000", "172800", "177600", "182400", "187200", "192000"		"9600"	
6.3.2	Configure modbus parity, 2 stop - no parity, 1 stop - even parity, or 1 stop - odd parity	"2S-NP", "1S-EP" or "1S-OP"		"2S-NP"	
6.3.3	Configure modbus I.D.	0-255		10	
7.0.0	Advanced settings	"ADV.SET"			
8.0.0	System settings	"SYSTEM"			
8.1.0	Factory reset	"F RESET"			
8.1.1	Enter passcode "369"	000-999	369	Lock symbol	
8.1.2	Apply factory defaults	"NO" or "YES"		"NO"	
8.2.0	HMI Firmware	"HMLINF"			
8.2.1	Displays HMI firmware REV	"R19"			
8.2.2	Displays HMI COMMS API REV	"4"			
8.3.1	Accumulated motor run time in hours	MTIME			
8.3.2	Motor run time reset password	MTIME	369		
8.3.3	Motor run time reset confirm	M RES YES	YES or NO		

Display I.D.			Function	Display Text	Range	Default	Symbol
EXIT	EXIT	EXIT	Exit screen	"EXIT"			
			Max level reached	"MAIN R1" / "MAX"; "PRE R2" / "MAX"; "GEN R3"/"MAX"			
			Min level reached	"MAIN R1" / "MIN"; "PRE R2" / "MIN"; "GEN R3" / "MIN"			
			Latch reset of alarms has been activated by holding the down button for 3 seconds	"LAT.RES"			
			Out of range (This message only appears with actual load and actual current)	"O O R"			
			If a communications error occurs with the sensor	"C Err"			
			Over voltage on sensor input	Top digits: "VOLT", Bottom digits: "OVER"			
			Over current on sensor CT inputs	Top Digits: "AMP", Bottom digits: "OVER"			
			Sensor USB plugged in	"SEN.USB"			
			HMI and sensor firmware incompatible	"API ERR"			

Technical Data

Dimensions	See Installation Sheet
Weight	See Installation Sheet
Temperature - operating	-10 to 50°C (14 to 122°F)
Temperature - storage	-20 to 70°C (-4 to 158°F)
Max. Altitude	2000M (6562 feet)
Relative Humidity (non-condensing) Continuous	0-85%
Relative Humidity (non-condensing) Intermittent	0-95%
Over Voltage category (IEC664)	II
Pollution Degree (IEC664)	2
IP / NEMA Rating (Display / HMI from the front)	IP65 / Type 4 and Type 12
Supply Voltage	1 x 100-240VAC or 3 x 200-480VAC
Supply Fuses	Type F, 0.5A Slow Blow with breaking capacity ⁽¹⁾ of 35A or greater. Fuse voltage must be equal to or greater than connected supply voltage.
Frequency	50 or 60 Hz
Electronics power consumption	5w
Current Transformers (CT)	ProcessDefender Current Transformers, 10A, 20A, 50A, 100A, 150A, 200A. Up to 1000A special order.
CT Output	33 mV at Full Scale
Nominal Accuracy (10%-100% of full range)	>99%

Relay Outputs

Breaking capacity	1250VA
Max. Switch Voltage	240 VRMS / 30VDC
Max. Current	5A

Analog Output

Output	4-20mA
Accuracy	>99%
Resolution	0.02mA

Digital Input

Input Voltage	24-48VDC / 24-240VAC
Input Impedance	200k Ω

Connections

Type	Screw terminals
Wire Type	Copper, solid or stranded
Min. Cable Temperature Rating	65°C (149°F)
Wire Strip Length	6.5 to 7.0mm ((0.26 to 0.28"))
Wire Gauge	0.8mm ² to 3.3mm ² (18AWG to 12AWG)
Torque	0.5 to 0.6Nm (4.42 to 5.31 lb/in.)
Approved to	CE, UL, cUL up to 500VAC, UKCA

Dimensional Details

▶ HMI Display

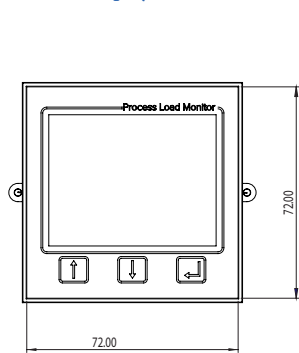

Fig.10.0

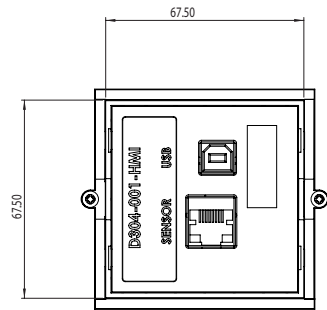

Fig.10.2

Note: all dimensions shown are in millimeters (mm).

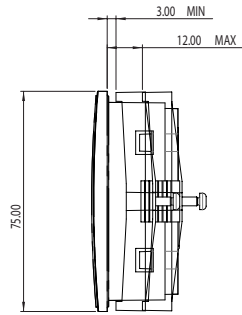

Fig.10.1

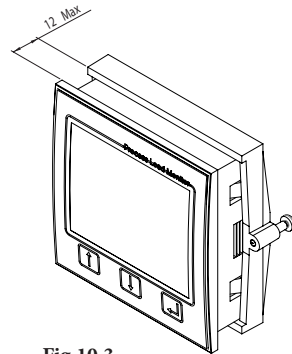

Fig.10.3

▶ Sensor

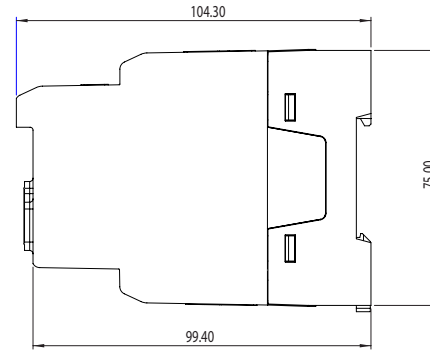

Fig.10.4

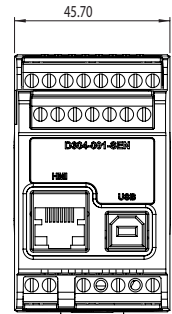

Fig.10.5

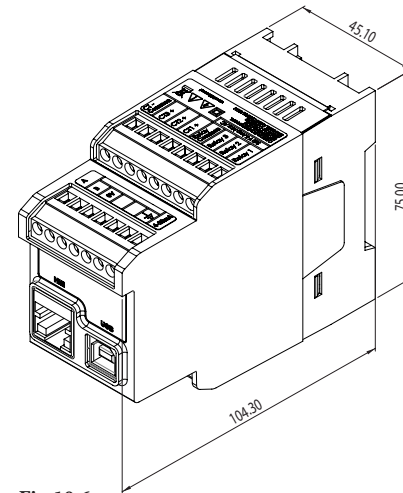

Fig.10.6

Service Information

This manual is valid for ProcessDefender model PD100.

H2flow Controls, Inc. reserves the right to alter product specifications without prior notification. No part of this document may be reproduced without permission from H2flow Controls, Inc.

For general product inquiries that are not answered in this document, please contact us at:

Global (except Europe)

Tel: 888 635 0296
sales@h2flow.net
www.h2flow.net

Europe

Tel: (+34) 609 3152 82
info@h2floweurope.com
www.h2floweurope.com

For inquiries relating to shipping, sales support, marketing support, or technical support questions that are not addressed in this document, please refer to the contact information provided below. You may also choose to visit our website (www.h2flow.net) to browse our library of product literature, videos and more.

Main Office

Tel: (+1) 888 635 0296
Fax: (+1) 419 517 9900

H2flow Controls, Inc.
3545 Silica Road, Unit F
Sylvania, OH 43560
USA

Shipping Inquiries

Rich Griffith
Direct: (+1) 419 464 9504
rich.griffith@h2flow.net

Sales Support

Matt Hackett
Direct: (+1) 419 464 9502
matt.hackett@h2flow.net

Marketing Support

Gavin Hackett
Direct: (+1) 860 748 4398
gavin.hackett@h2flow.net

Technical Support

Dave Atkins
Direct: (+1) 419 309 7218
dave.atkins@h2flow.net

Warranty

Exclusions:

This warranty shall not apply to any defect, failure or damage caused by improper use or improper or inadequate care. H2flow Controls Inc. shall not be obligated to provide service under this warranty if:

- a) damage has been caused by a failure to make a full and proper inspection of the product (as described by the documentation enclosed with the product at the time of shipment) on initial receipt of the product following shipment;
- b) damage has been caused by the attempts of individuals, other than H2flow Controls Inc. staff to repair or service the product;
- c) damage has been caused by the improper use of the product, including but not limited to, breakage or damage to the instrument sensors or cracking of the instrument display, the splicing or cutting of cables or wires unless explicitly instructed to do so during the installation process. General misuse of the product.

Charges:

Under cover of this warranty, H2flow Controls Inc. will pay the carriage and insurance charges for the shipment of defective product back to H2flow Controls Inc. and for its return to the client's original site of dispatch except when:

- a) H2flow Controls Inc's product return policy has not been followed.
- b) product failure is caused by any of the exclusions described above, when the customer will be liable for the full cost of the repair (parts and labor) plus all carriage and insurance costs to and from H2flow Controls Inc's premises.
- c) the product is damaged in transit and a contributory cause is inadequate packaging. It is the customer's responsibility to ensure that the packaging used to return equipment to H2flow Controls Inc. is the same, or has equivalent protective qualities, to that used to ship the product to the customer in the first instance. Any damage resulting from the use of inadequate packaging will nullify H2flow Controls Inc's obligations under this warranty.

The manufacturer agrees during the warranty period of 24 months from date of purchase, to repair or replace (at its option) any defect in material or workmanship.

Should the customer's product be damaged in transit following a repair at H2flow Controls Inc's site, a full photographic record of the damage must be obtained (packaging and the product) to support any claim for recompense. Failure to present this evidence may limit H2flow Controls Inc's obligations under this warranty.

THIS WARRANTY IS GIVEN BY H2FLOW CONTROLS INC. IN LIEU OF ANY OTHER WARRANTIES, EXPRESSED OR IMPLIED, INCLUDING BUT NOT LIMITED TO ANY IMPLIED WARRANTY OF MERCHANTABILITY, NON INFRINGEMENT OR FITNESS FOR A PARTICULAR PURPOSE. H2FLOW CONTROLS INC SHALL NOT BE LIABLE FOR ANY SPECIAL, INDIRECT, INCIDENTAL OR CONSEQUENTIAL DAMAGES OR LOSSES. WE SPECIFICALLY DISCLAIM ANY AND ALL WARRANTIES TO CUSTOMERS OF THE CUSTOMER. THE CUSTOMER'S SOLE REMEDY FOR ANY BREACH OF WARRANTY IS THE REPAIR OR REPLACEMENT, AT H2FLOW CONTROLS INC'S DISCRETION, OF THE FAILED PRODUCT.

H2flow Controls, Inc.
3545 Silica Road, Unit F
Sylvania, OH 43560
USA

Tel: 888.635.0296
Fax: 419.517.9900
www.h2flow.net

